

OFFICE FOR CURRICULUM AND INSTRUCTION

*Ridgefield Park Public Schools
712 Lincoln Avenue
Ridgefield Park, New Jersey 07660*

Mr. Joseph Neubert
Assistant Superintendent for Curriculum and Instruction

Tel.: 201-807-2640
jneubert@rpps.net

Dear Parents/Guardians of Students Entering **Kindergarten**,

We are very excited to be welcoming your child to Kindergarten this September. Working with your child throughout the summer months to complete the attached activities will help to ensure your child has a successful start to their Kindergarten year.

In the attached packet, please have your child attempt the following:

- Complete the two mini booklets of basic skills that your child should be familiar with by the time they enter Kindergarten. (Please help your child cut the mini booklets along the dashed lines and staple as indicated.)
- Complete the coloring and pattern worksheets.
- Practice reciting the Pledge of Allegiance with your child each day.
- Complete the Kindergarten Readiness Skills Chart.

Please have your child return their summer packet to their teacher on the **first day of school**.

Thank you for your cooperation and support of this important Kindergarten preparation process. Enjoy your summer and have fun learning and exploring with your child!

Respectfully,

Mr. Joseph Neubert
Assistant Superintendent for Curriculum and Instruction

Ridgefield Park Public Schools

Welcome to Kindergarten!

Student's Name:



Now I know

my

ABCs

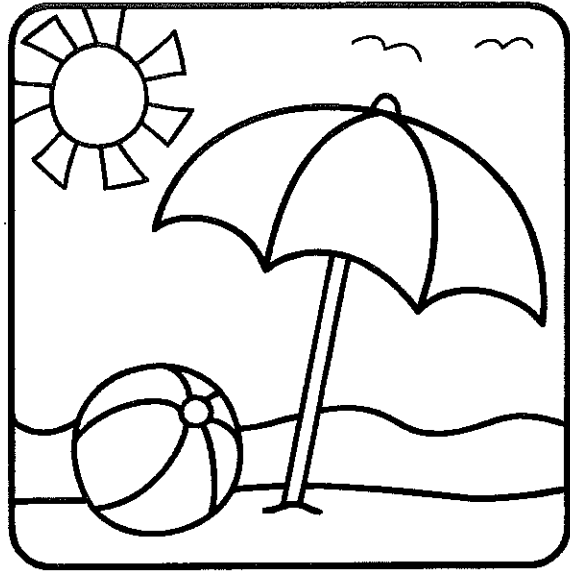

Name: _____

Trace and write:

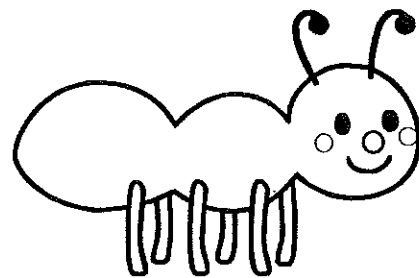
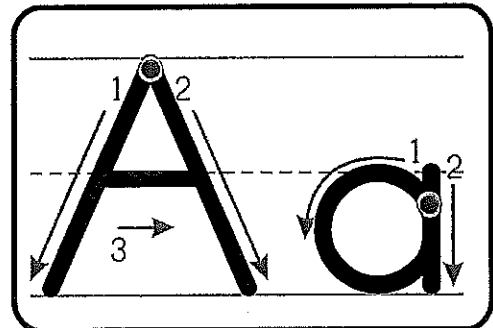
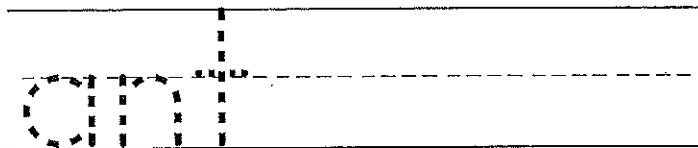
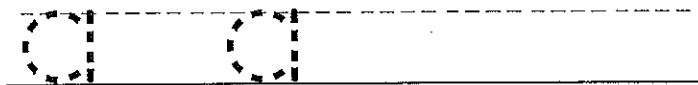
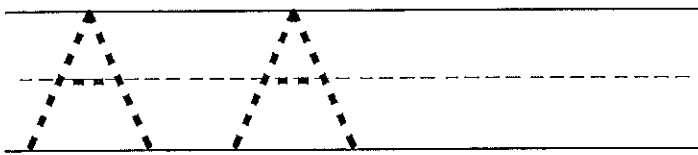

Color a

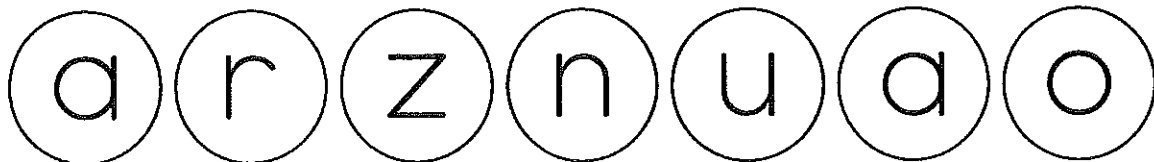

Trace and write:

B B

b b

bus

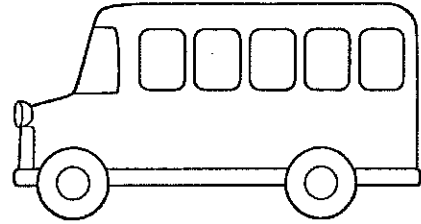
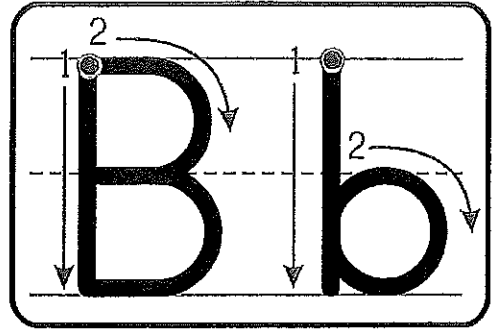

Color b

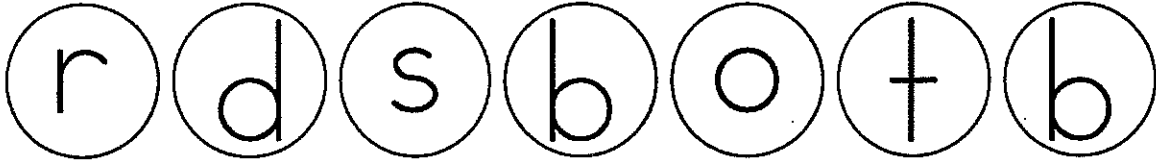

Trace and write:

C C

c c

cup

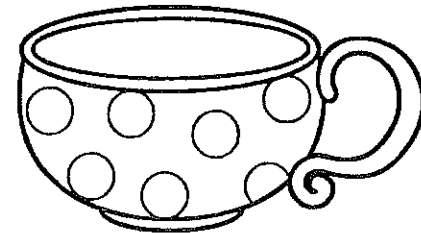
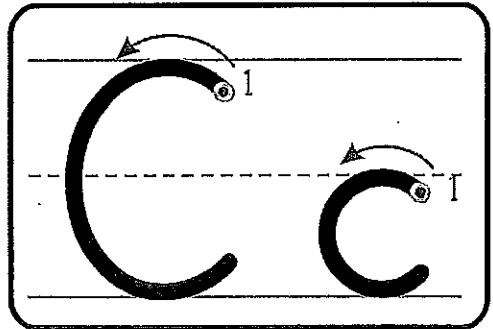

Color c

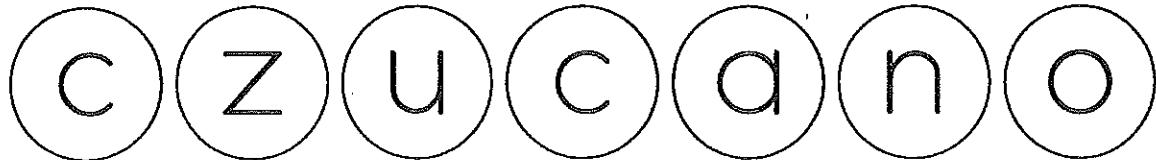

Trace and write:

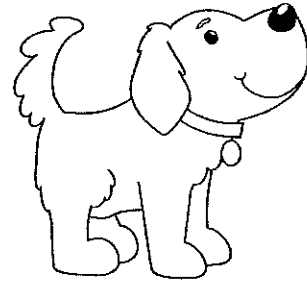
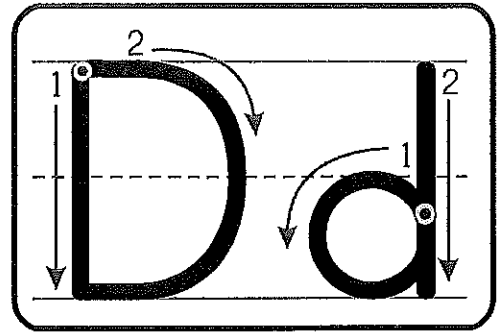
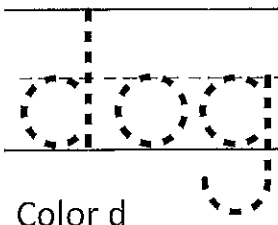
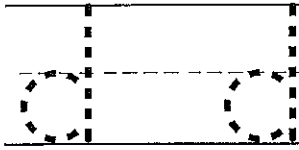
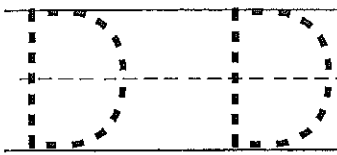

Color d

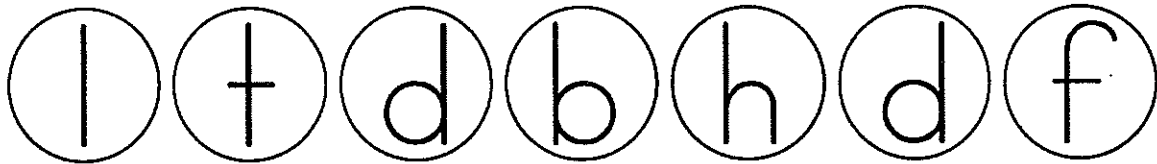

Trace and write:

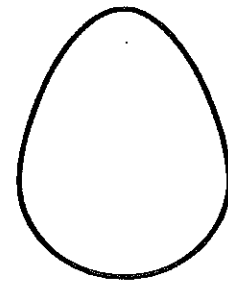
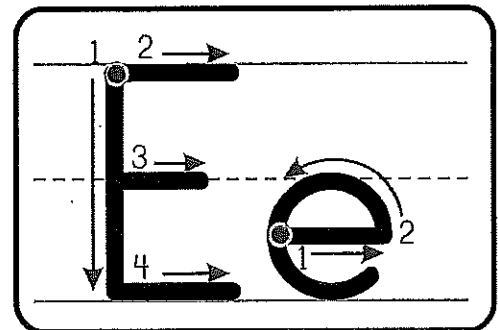
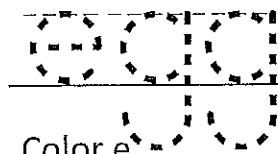
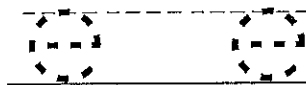
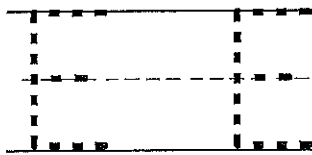

Color e

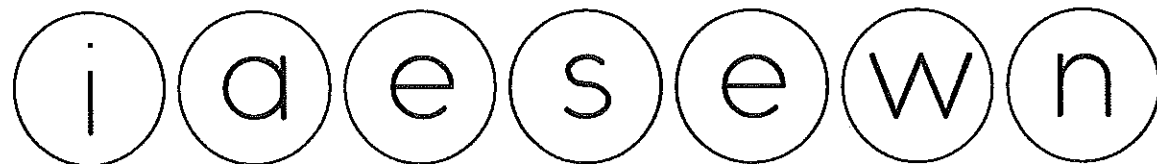

Trace and write:

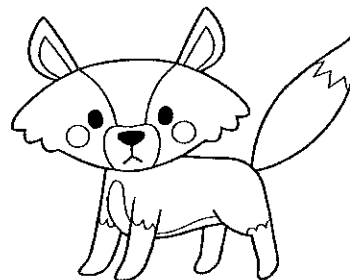
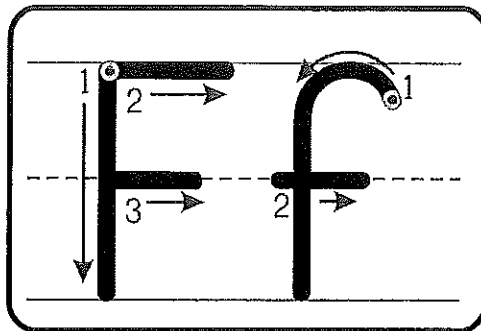
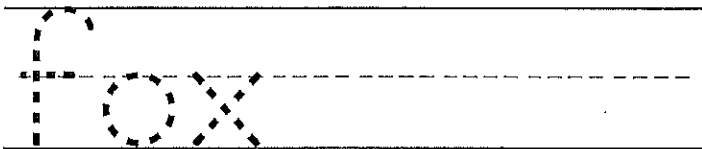
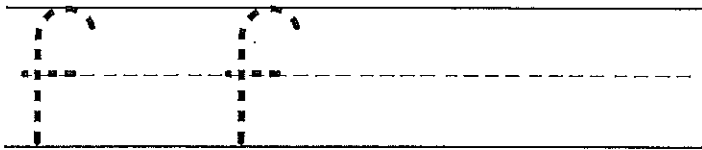
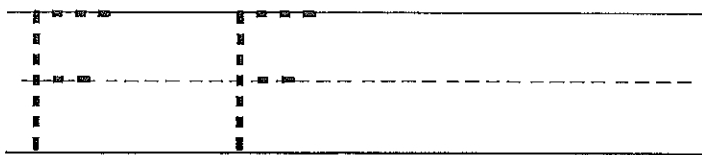

Color f

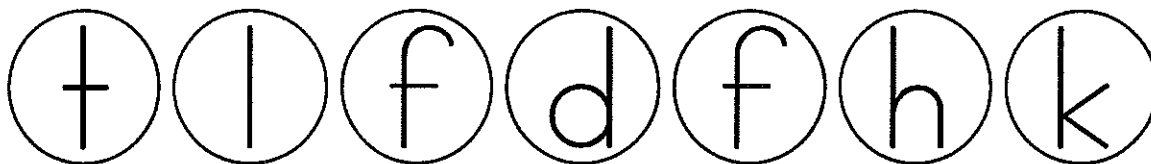

Trace and write:

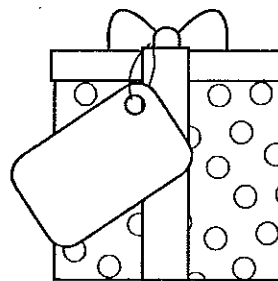
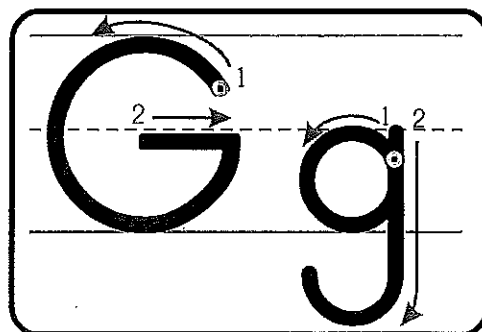
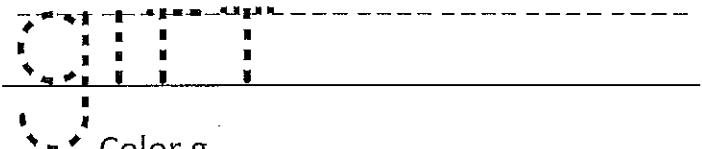
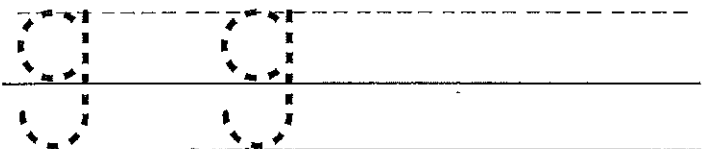
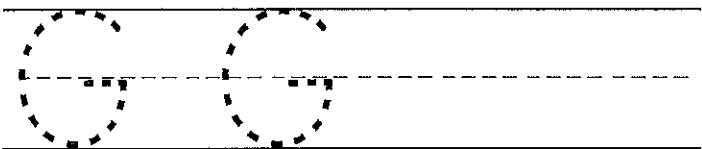

Color g

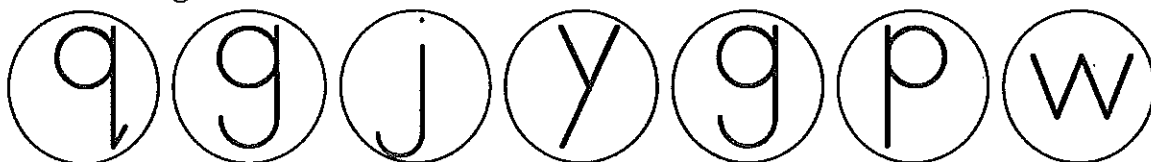

Trace and write:

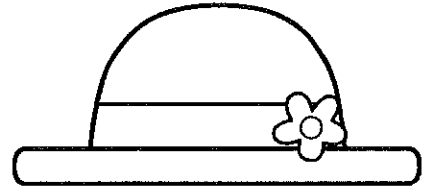
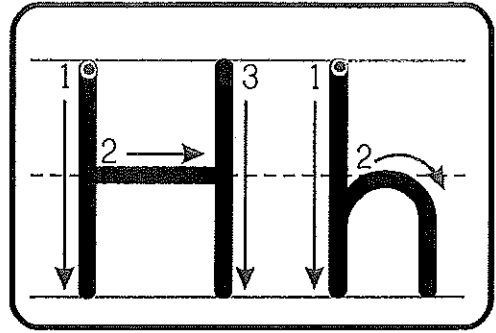
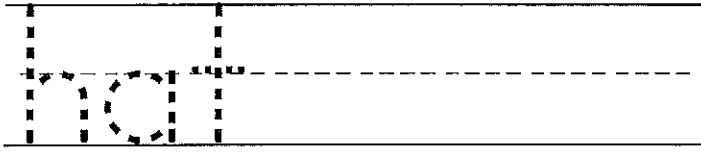
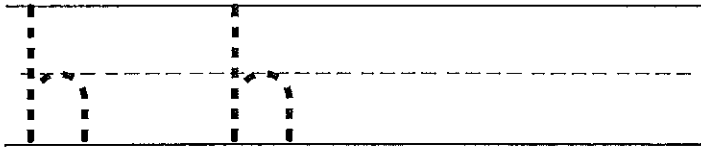
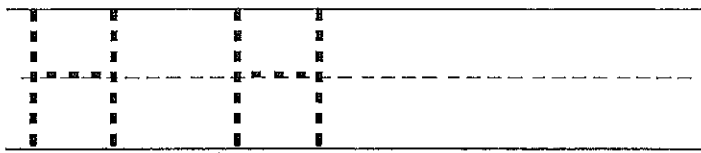

Color h

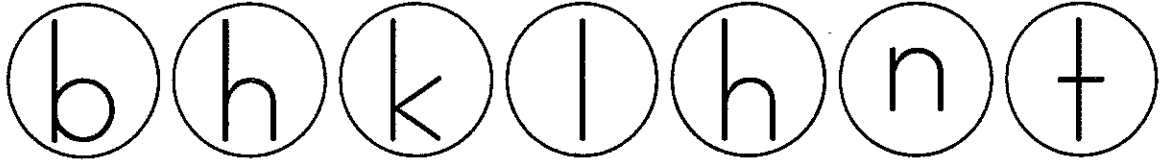

Trace and write:

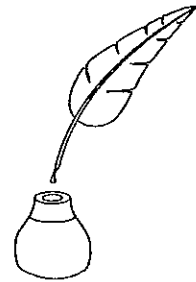
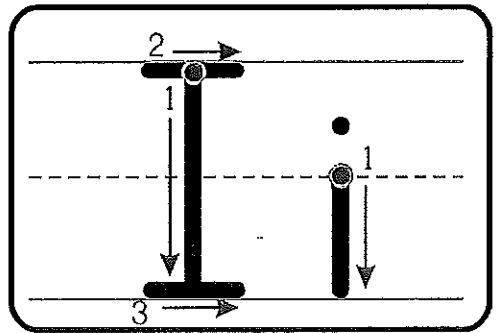
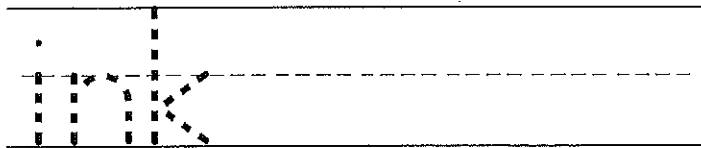
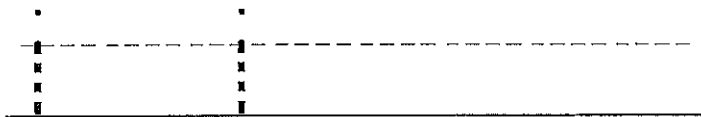
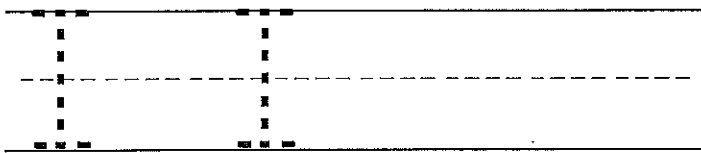

Color i



Trace and write:

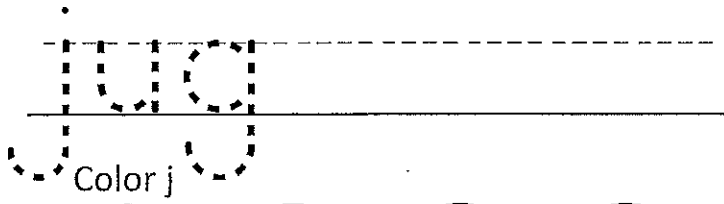
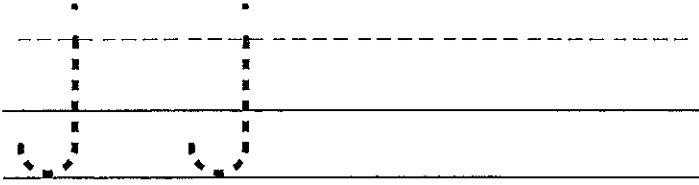
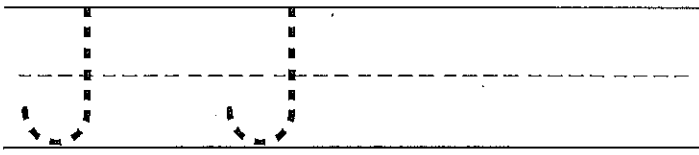

Color j

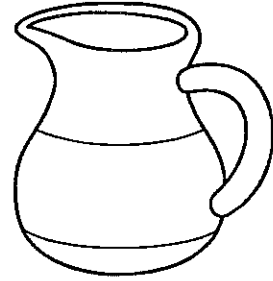
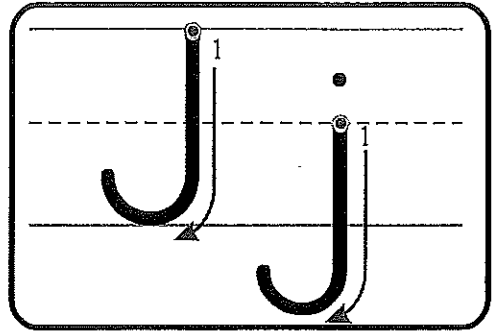
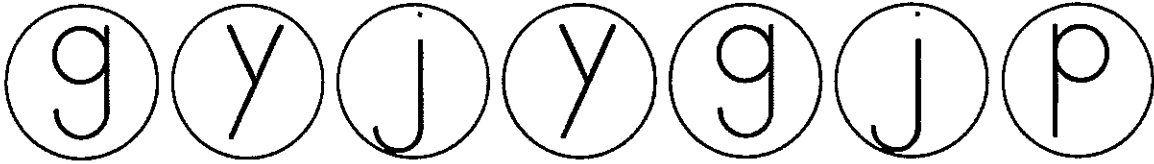

Trace and write:

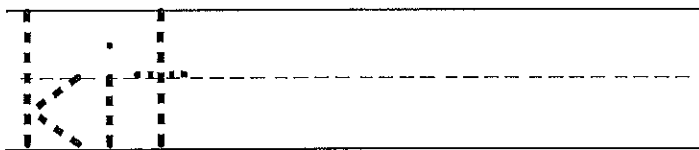
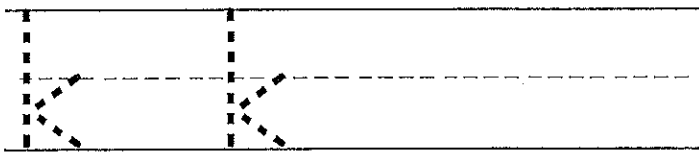
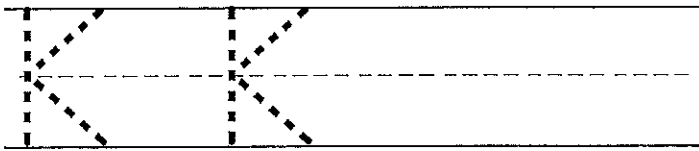

Color k

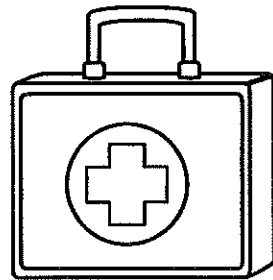
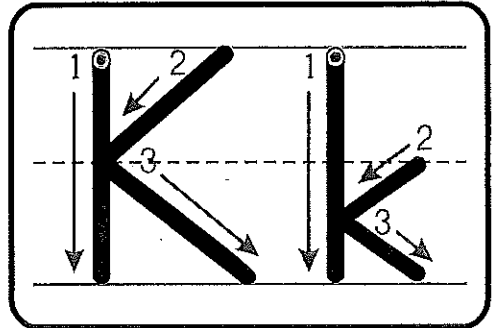
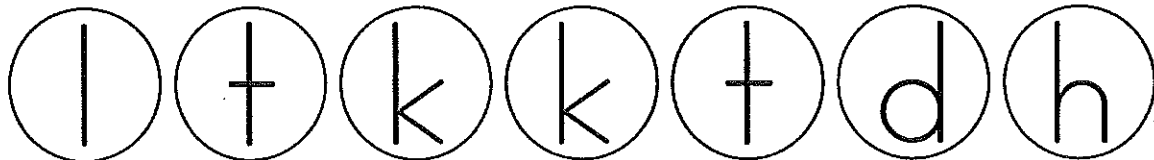

Trace and write:

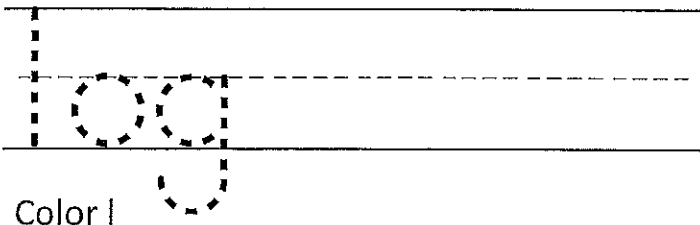
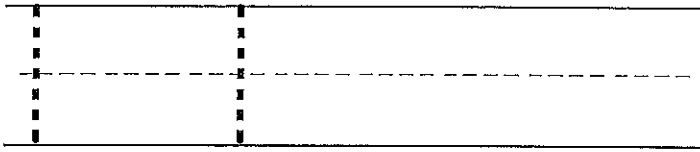
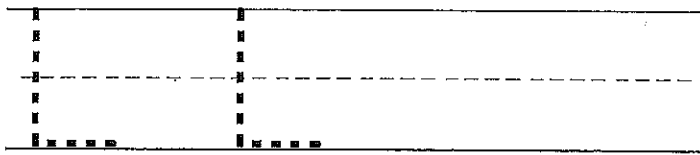

Color l

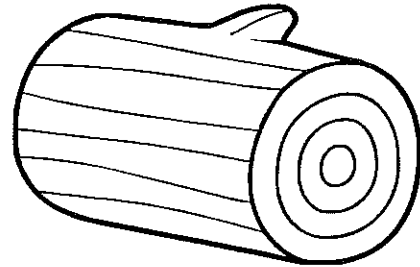
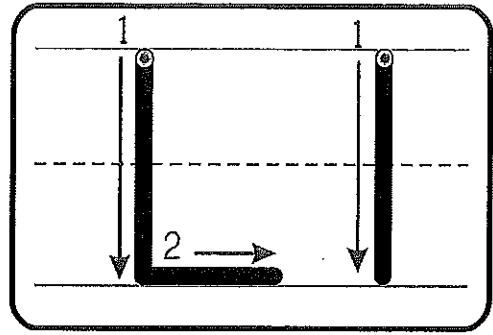
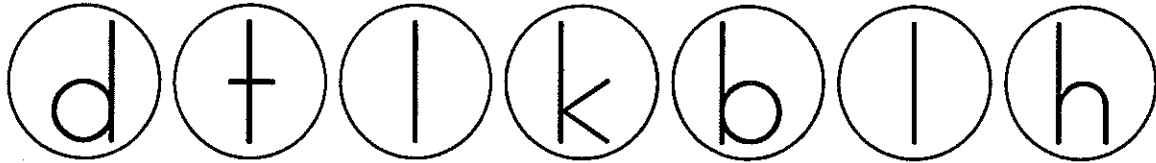

Trace and write:

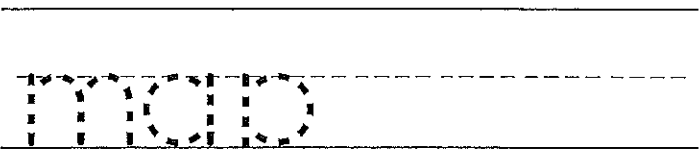
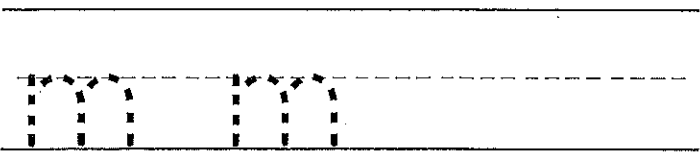
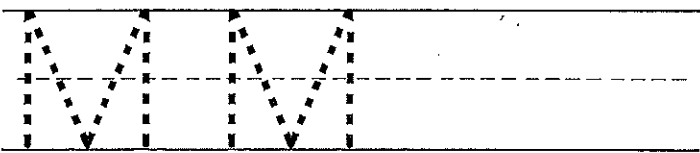

Color m

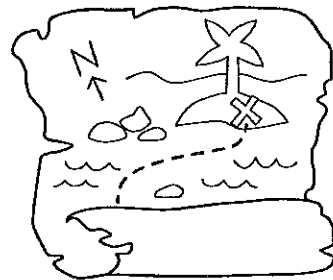
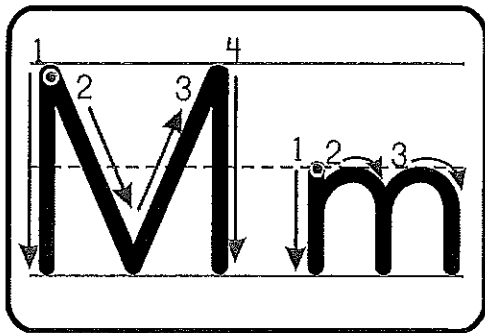
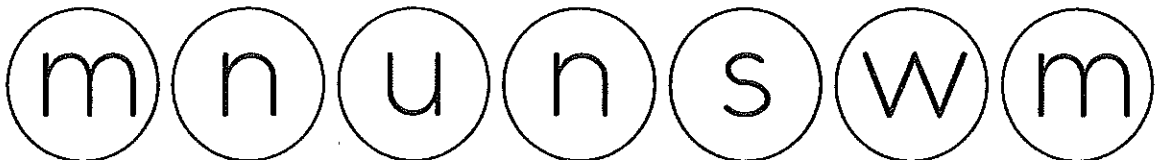

Trace and write:

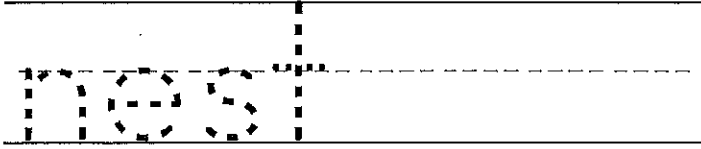
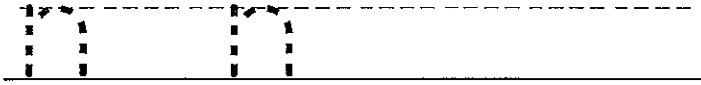
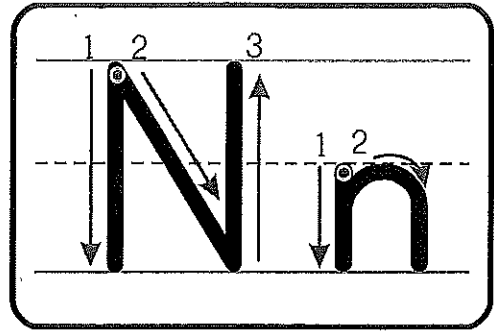
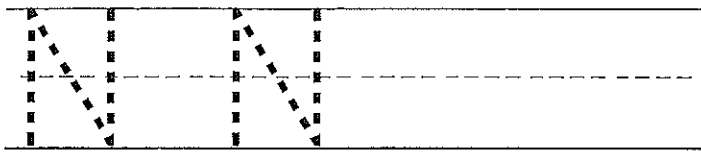

Color n



Trace and write:

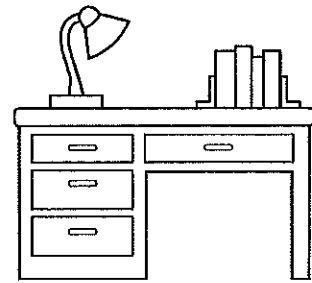
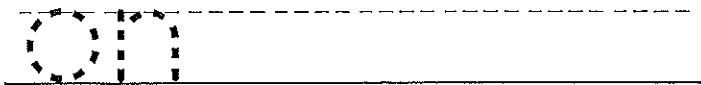
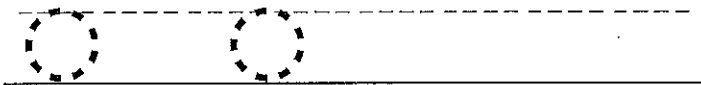
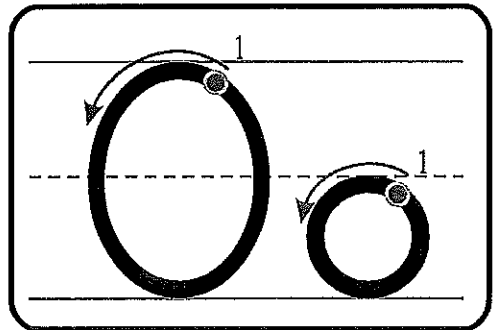
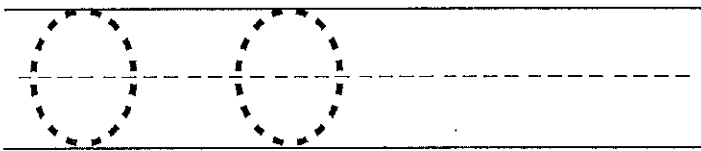

Color o

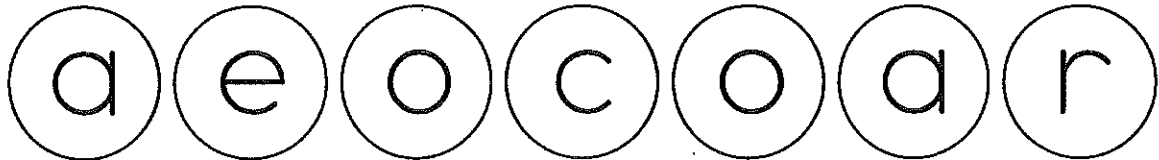

Trace and write:

P P

p p

pen

Color p

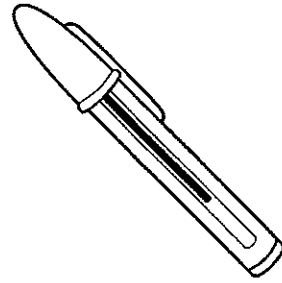
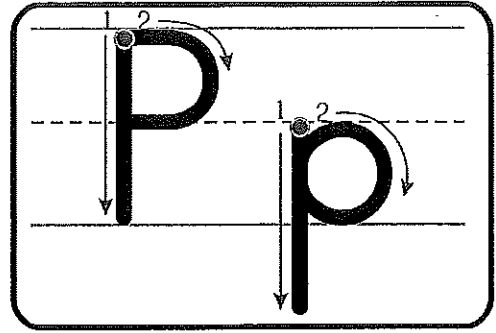
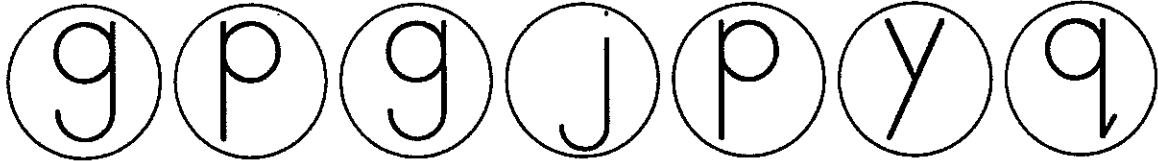

Trace and write:

Q Q

q q

quit

Color q

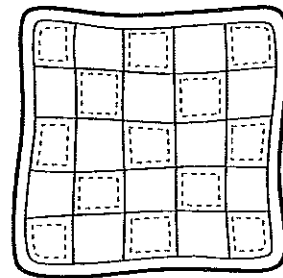
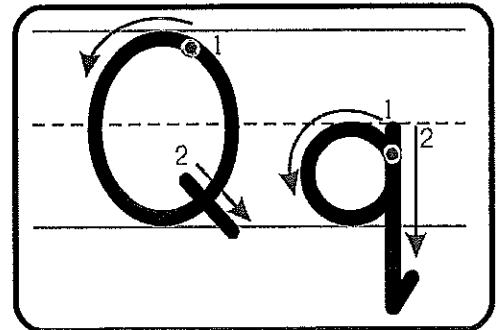
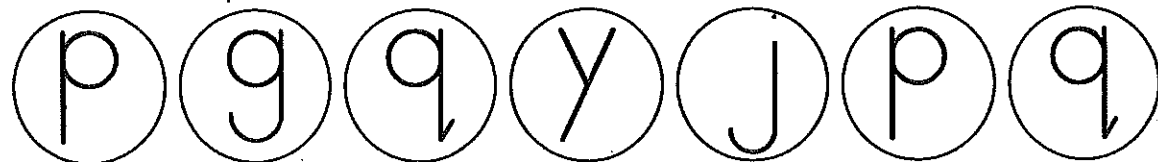

Trace and write:

R R

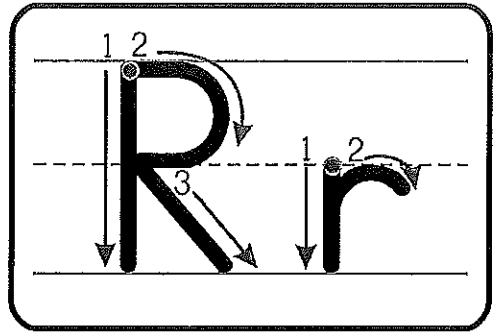

r r

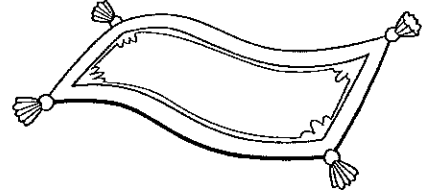

rug

Color r

r u n r c s e

Trace and write:

S S

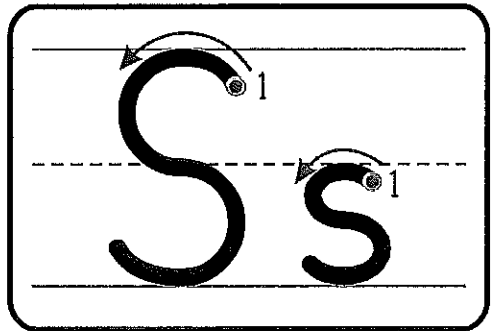

s s

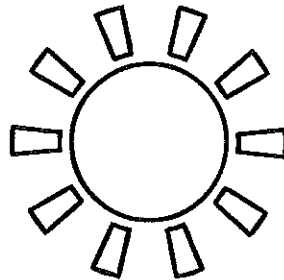

sun

Color s

z c s r e s v

Trace and write:

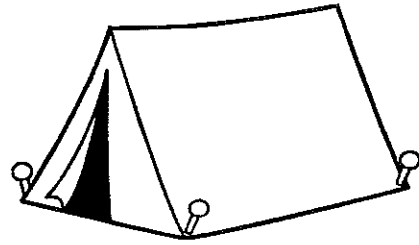
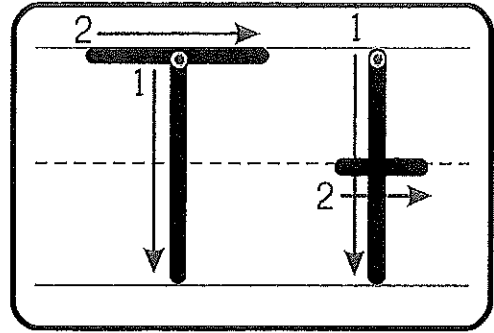
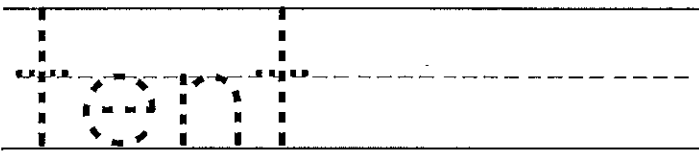
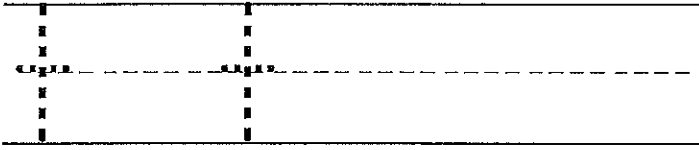
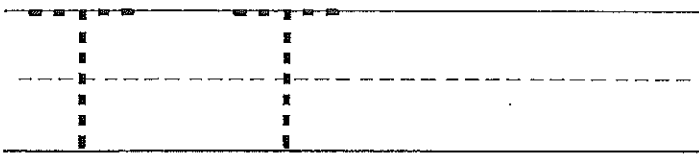

Color t

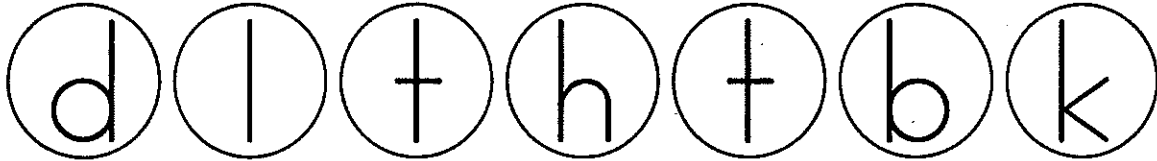

Trace and write:

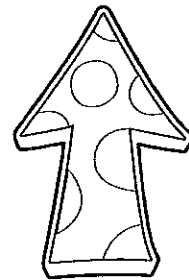
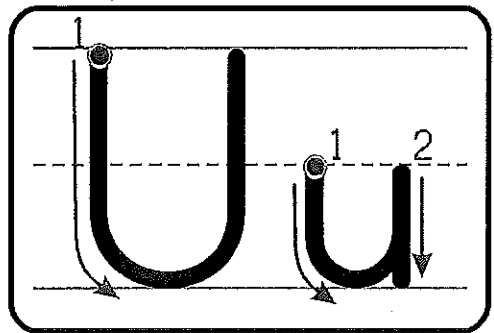
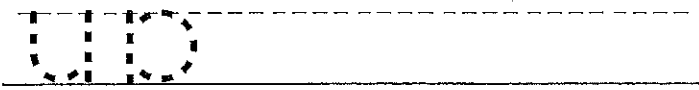
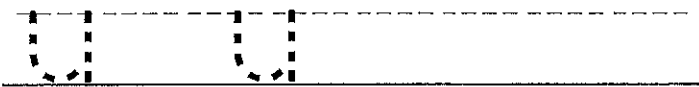
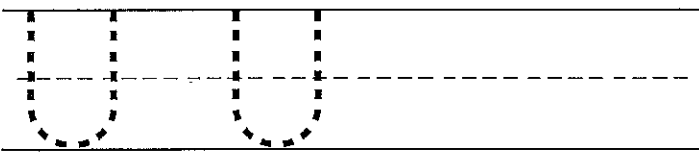

Color u

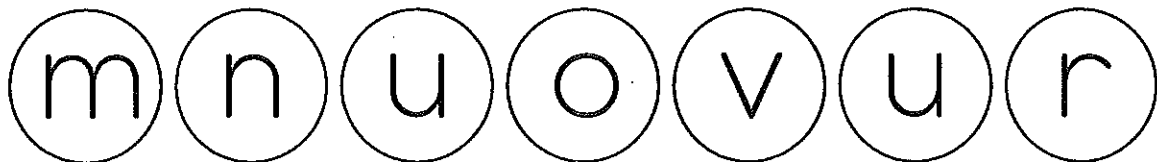

Trace and write:

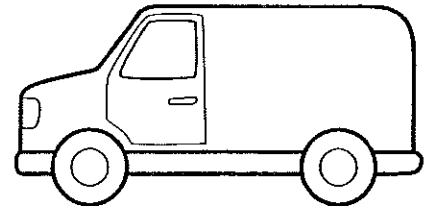
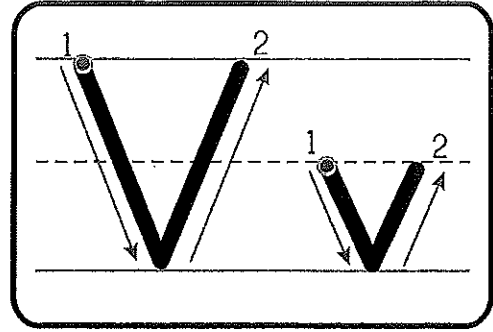
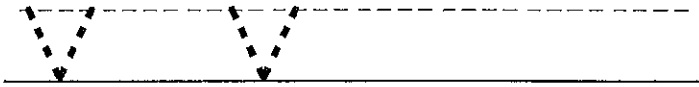
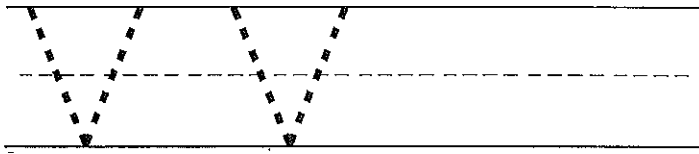

Color v

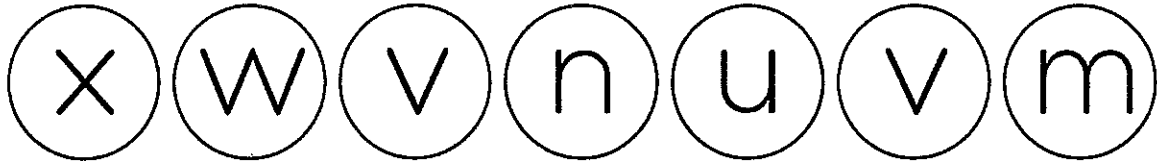

Trace and write:

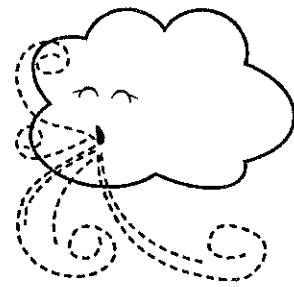
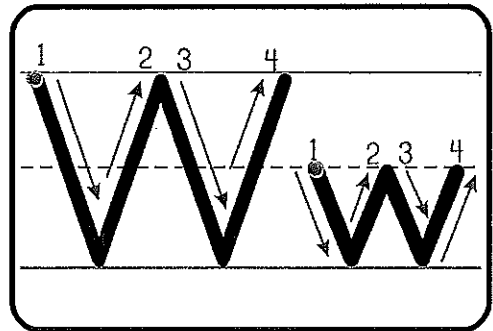
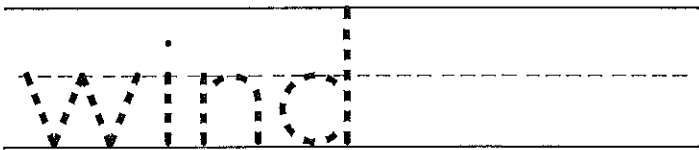
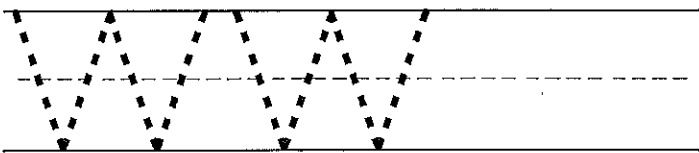

Color w



Trace and write:

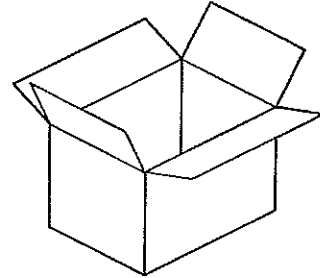
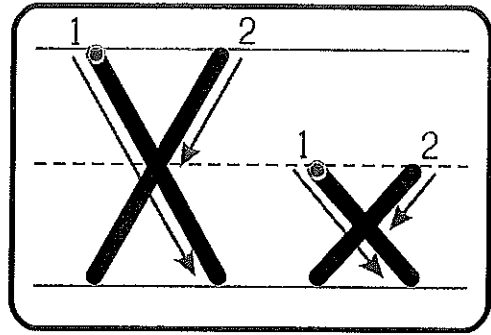
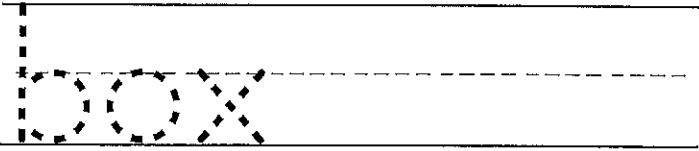
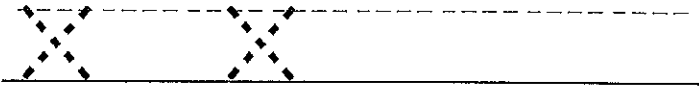
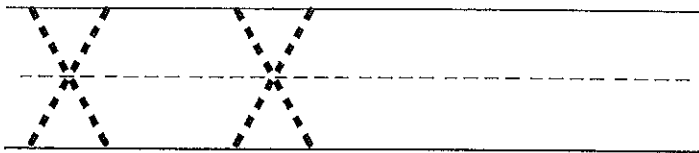

Color x



Trace and write:

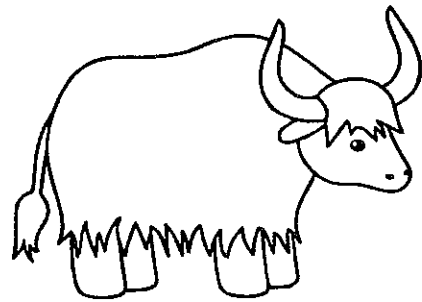
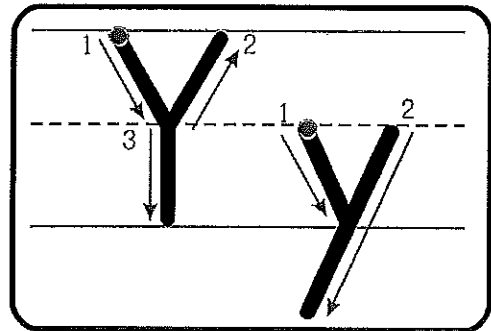
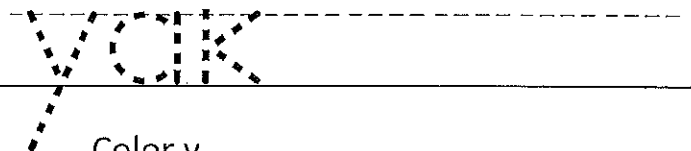
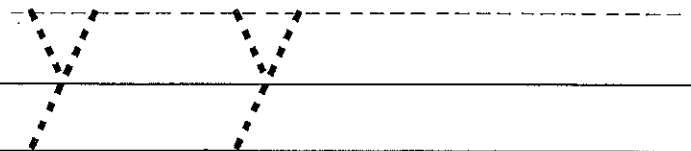
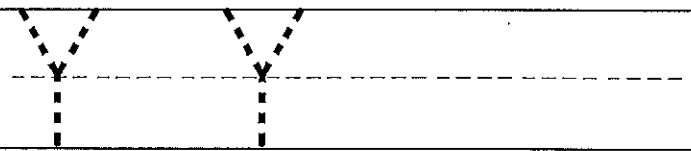

Color y

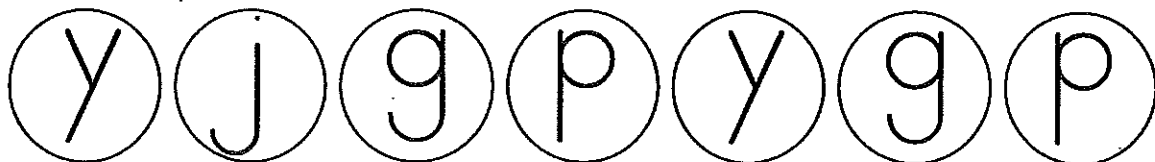

Trace and write:

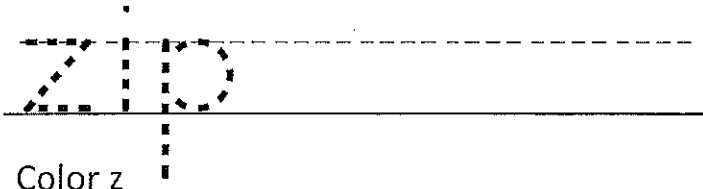
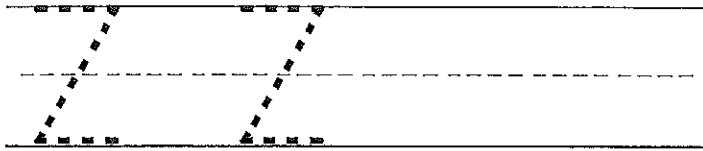

Color z

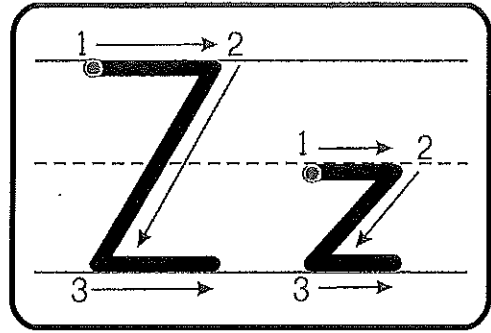
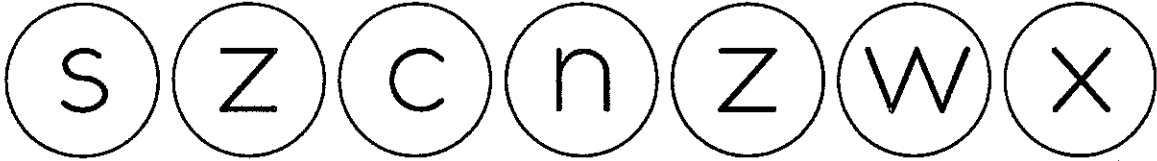

Counting at the BEACH

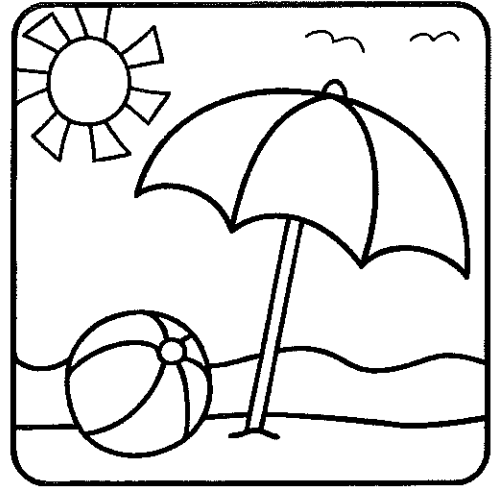

Name: _____

Trace the number 1

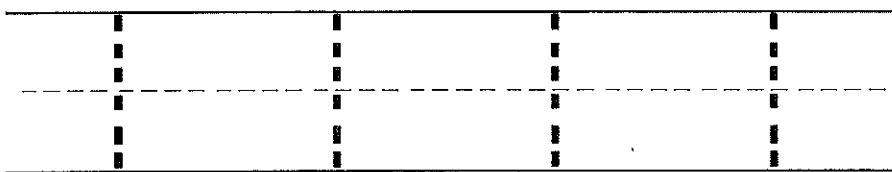

Circle the number 1

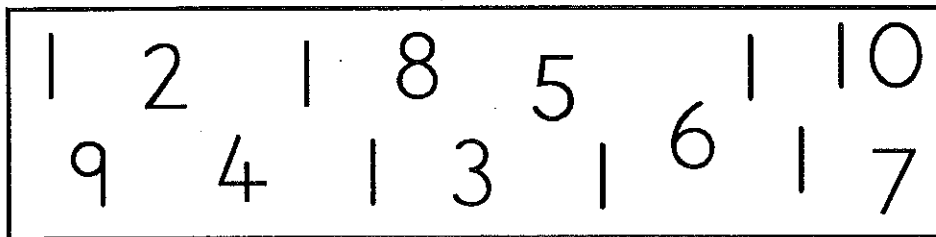

Color 1 sun.

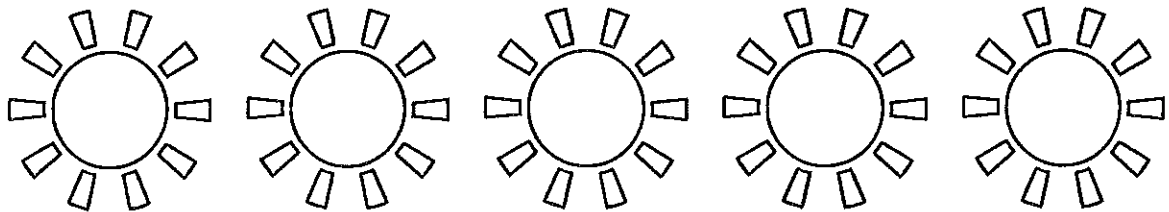

Trace the number 2.

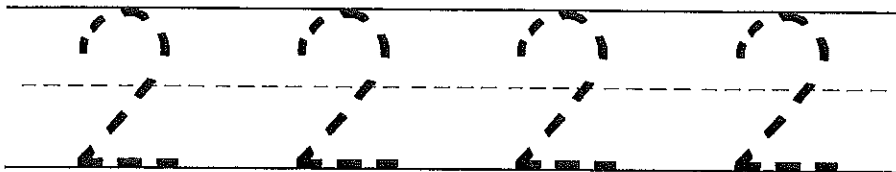

Circle the number 2.

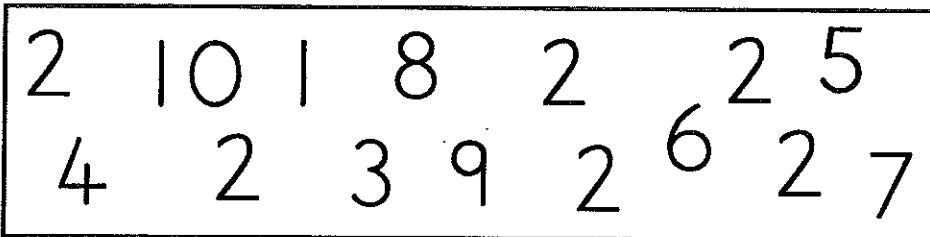

Color 2 watermelon slices.



Trace the number 3.

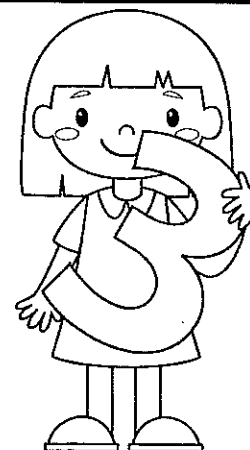
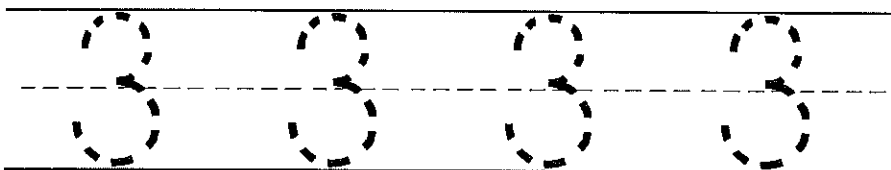

Circle the number 3.

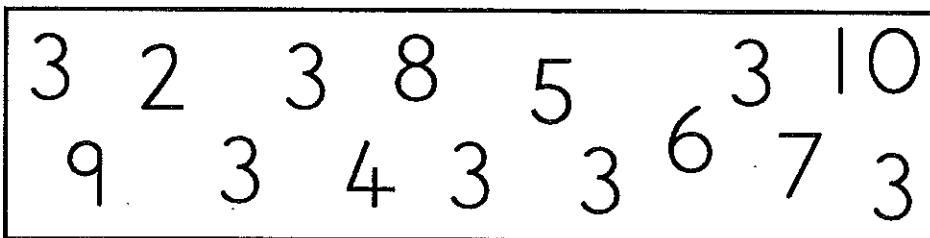

Color 3 kites.

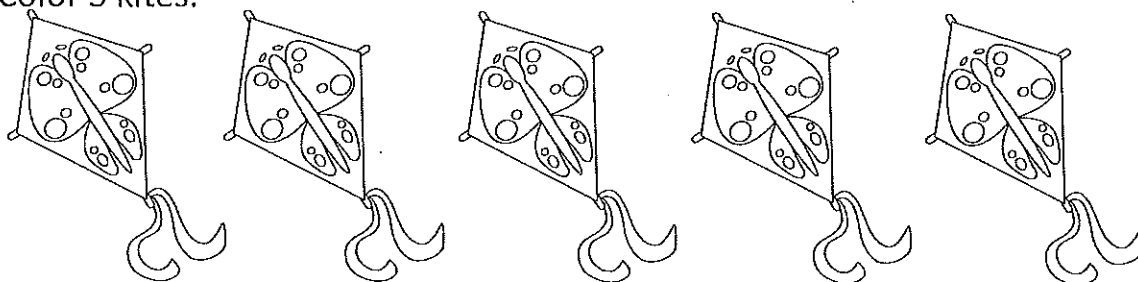

Trace the number 4.

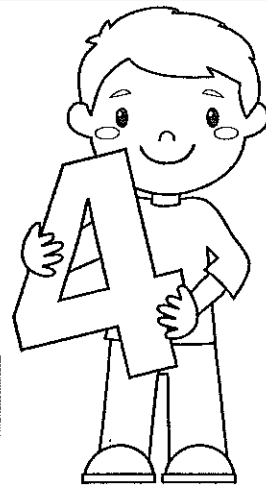
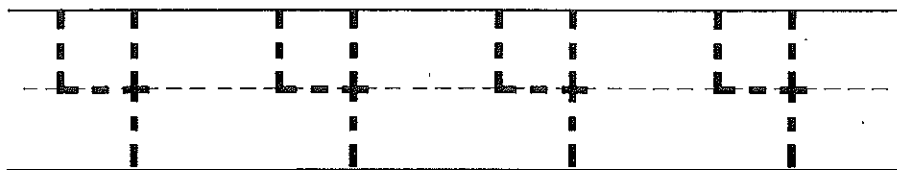

Circle the number 4.

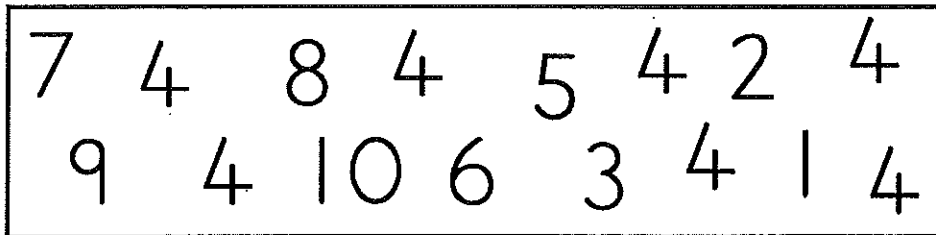

Color 4 beach balls.

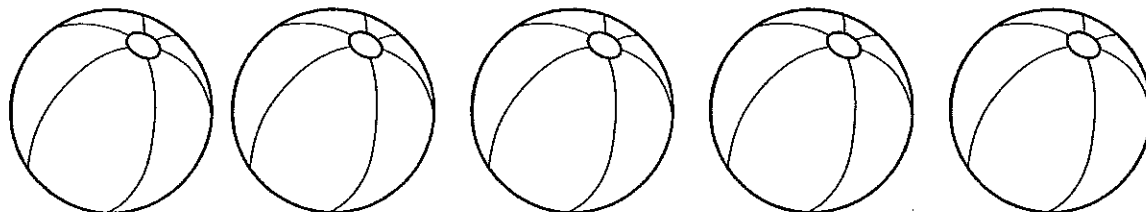

Trace the number 5.

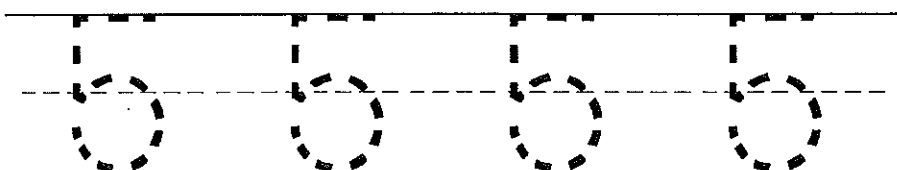

Circle the number 5.

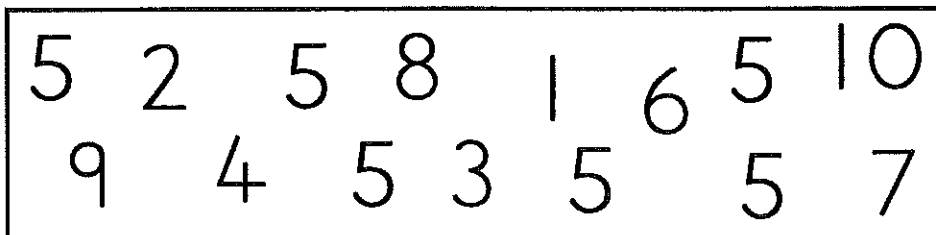

Color 5 sand castles.



Trace the number 6.

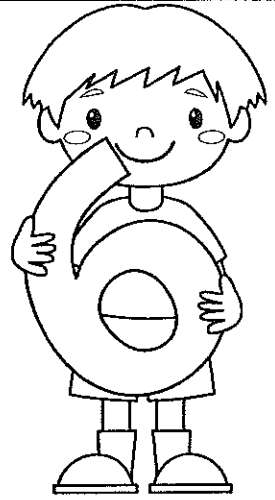
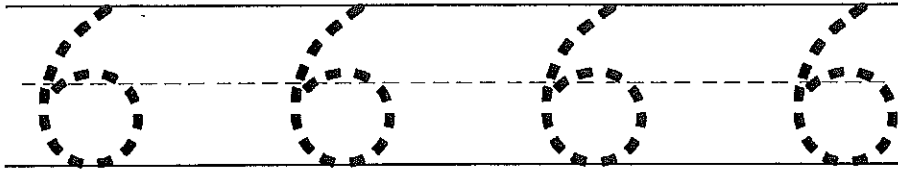

Circle the number 6.

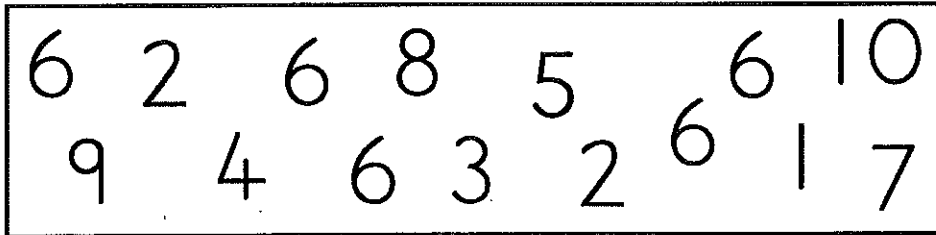

Color 6 crabs.

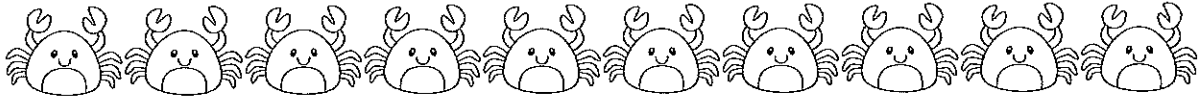

Trace the number 7.

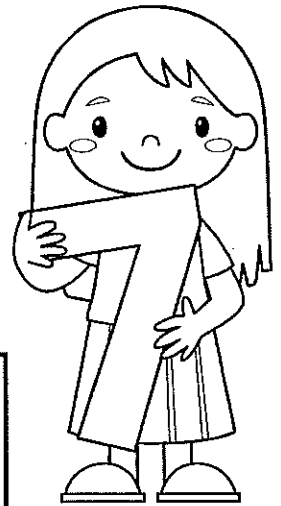
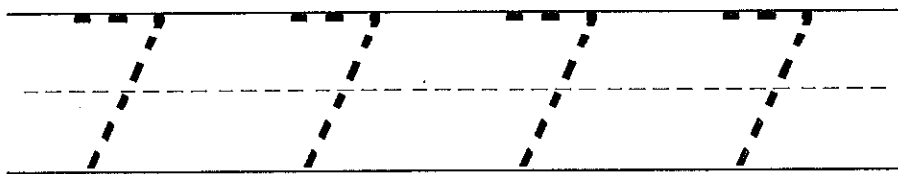

Circle the number 7.

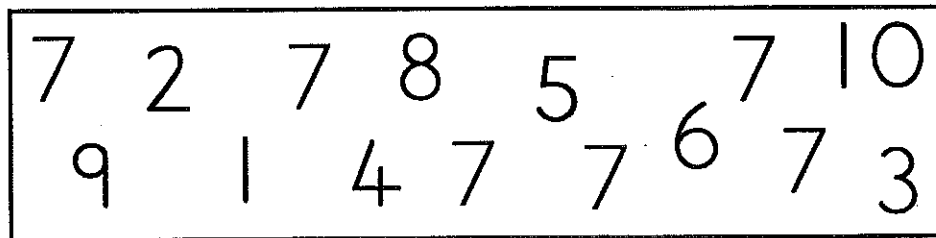

Color 7 shells.

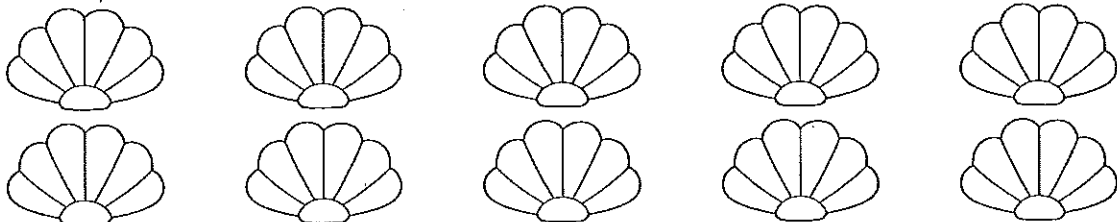

Trace the number 8.

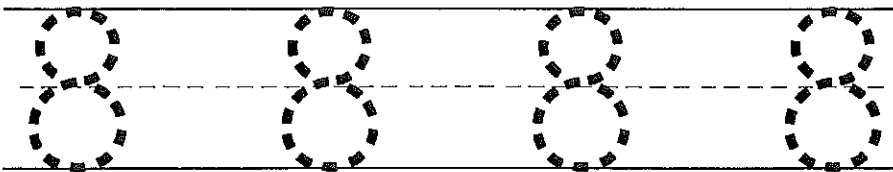

Circle the number 8.

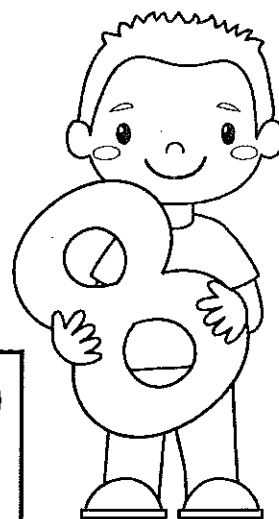
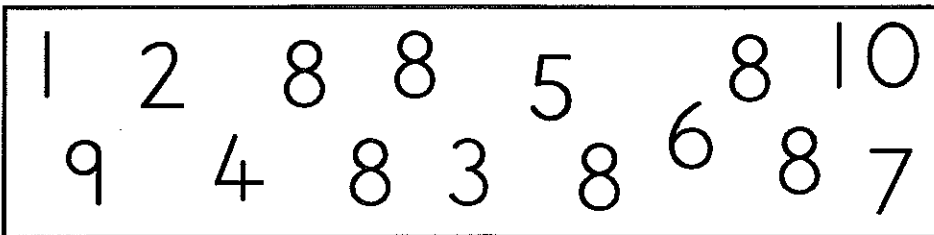

Color 8 beach umbrellas.



Trace the number 9.

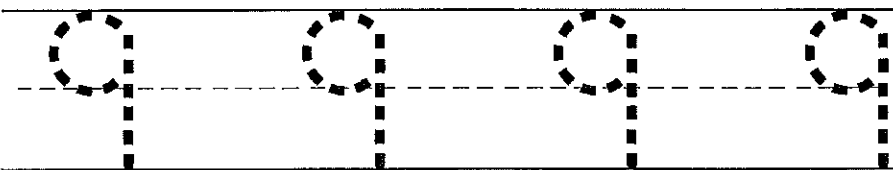

Circle the number 9.

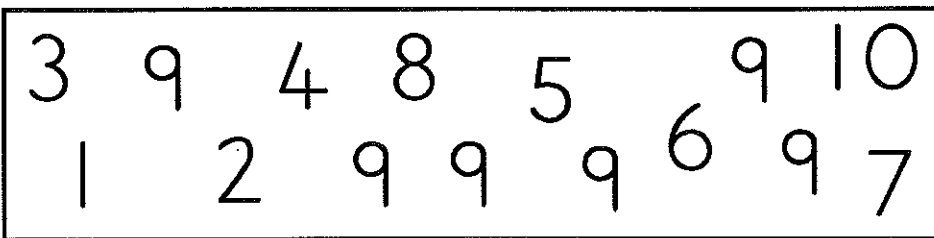

Color 9 sun hats.

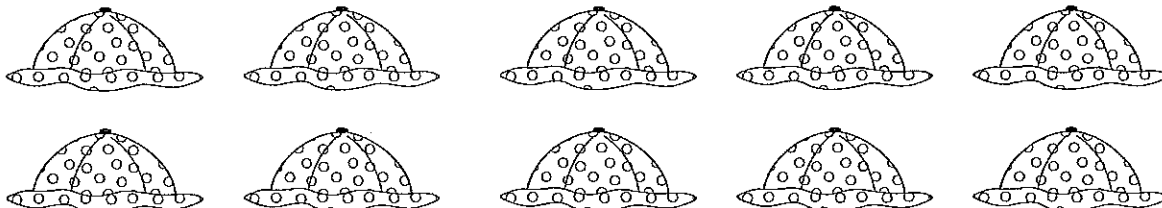

Trace the number 10.

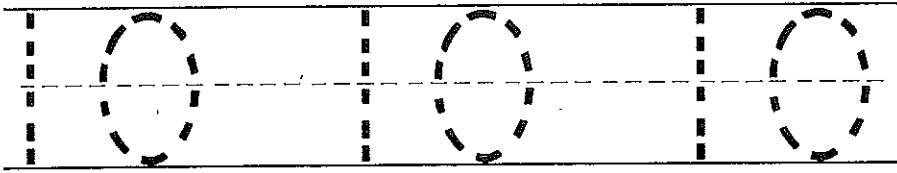

Circle the number 10.

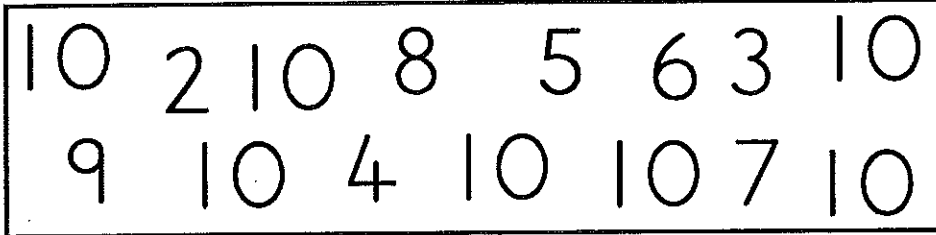

Color 10 ice creams.



Name: _____

Cut and paste the pictures to complete each pattern.

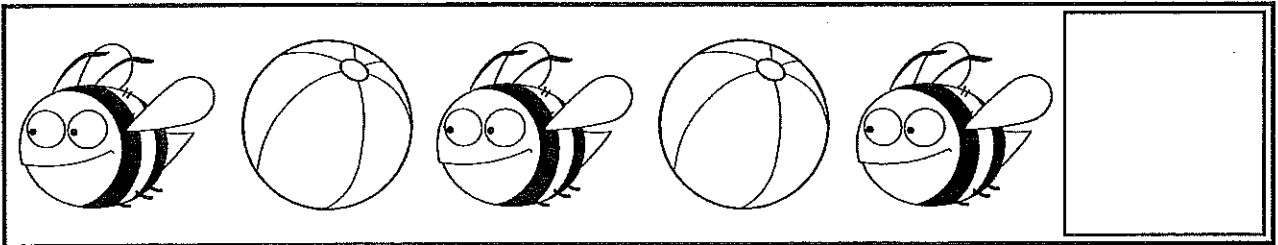
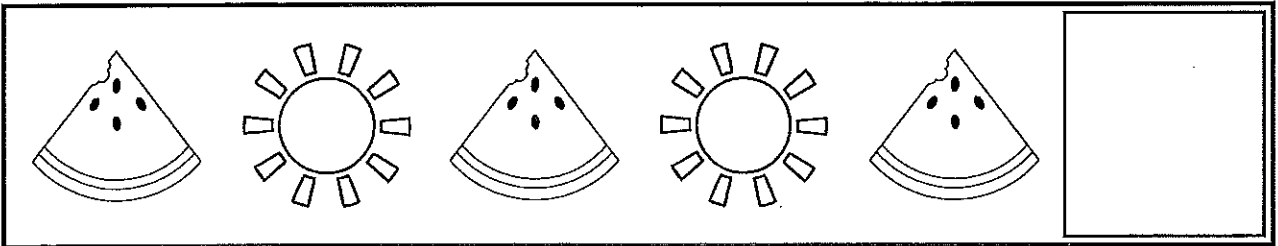
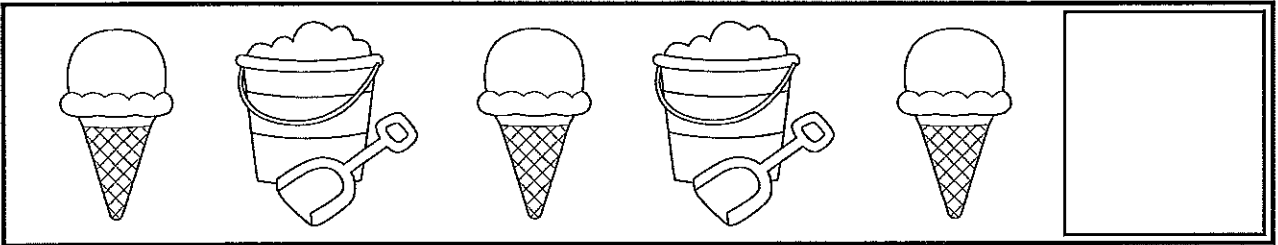
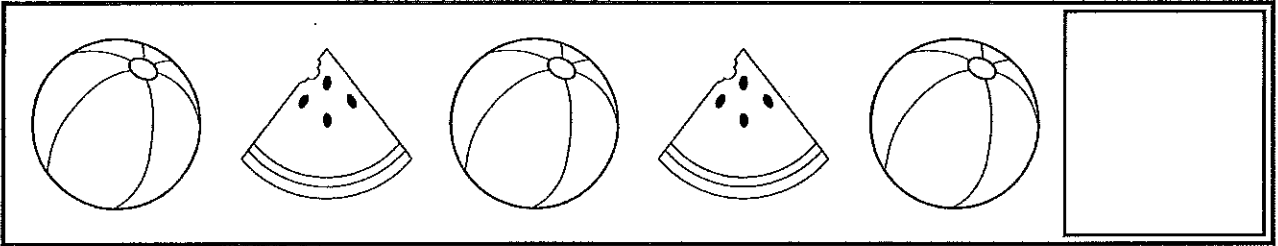
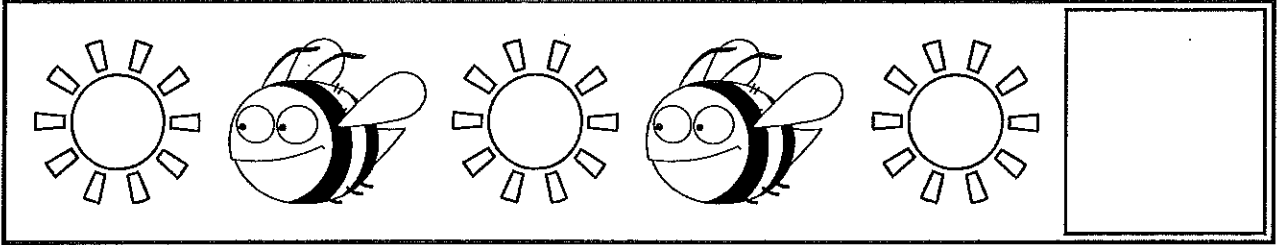

By Lavinia Pop © 2014

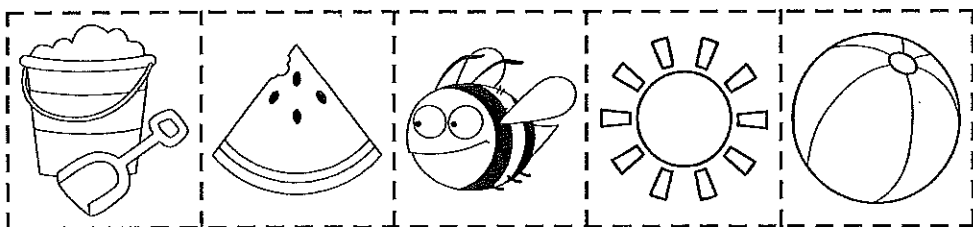
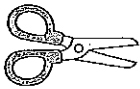

Name _____

ABC • 123 • ABC • 123 • ABC • 123 • ABC • 123 • ABC • 123 • ABC • 123 • ABC • 123 • ABC

Clowning Around

Color the clown and his balloons.

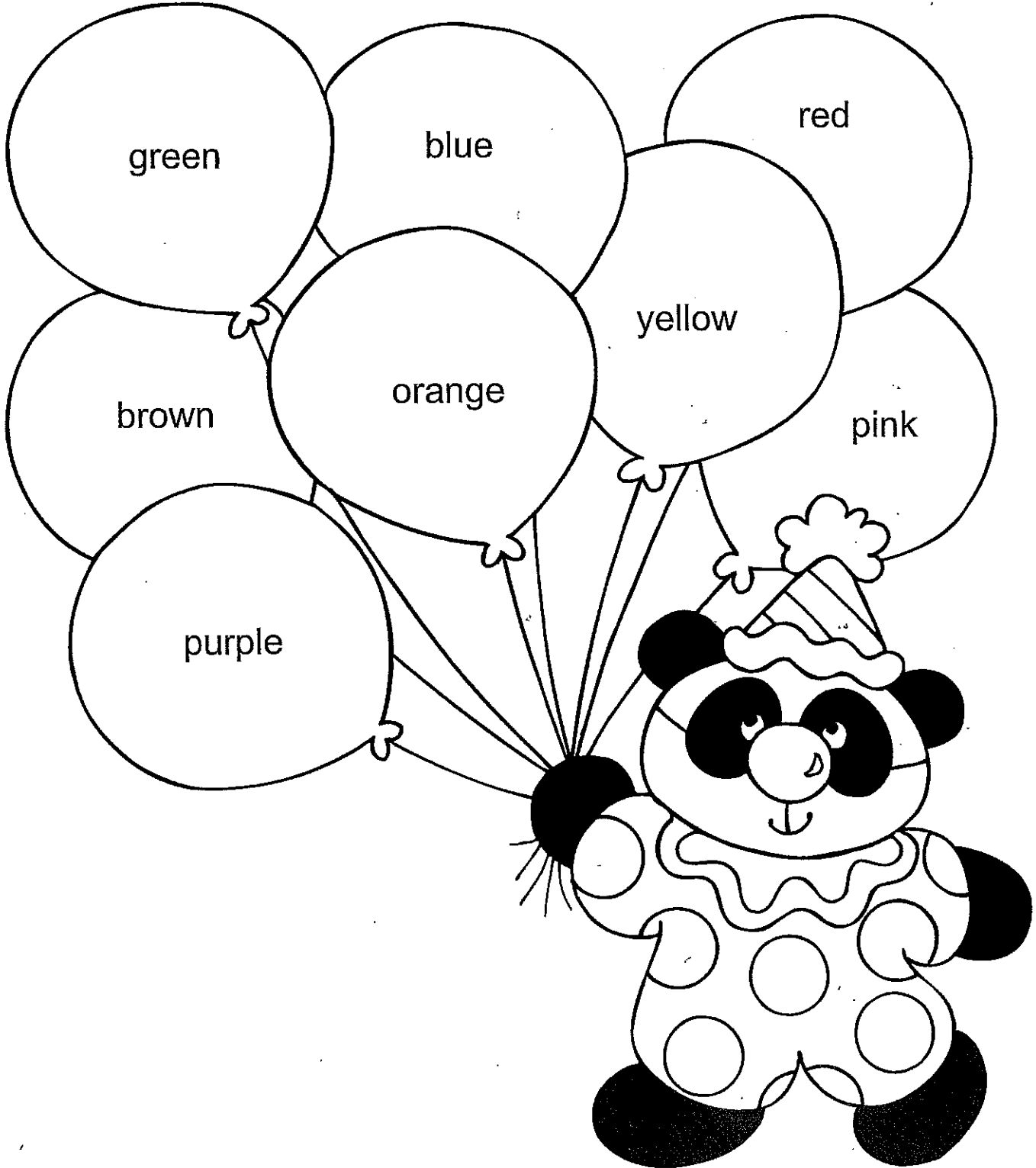

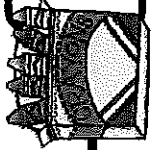

Kindergarten Readiness Skills

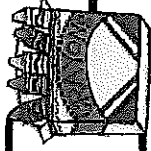

As you complete each task please check it off. When the calendar is complete, erase and start from the beginning. Continue until the first day of Kindergarten!

Practice your phone number with area code	Practice your house address with city and state	Read a book and talk about it	Make number cards 0-10 and practice saying them	Practice writing the alphabet	Practice saying your first and last name	Practice counting to 50
Make alphabet cards and practice saying them	<ul style="list-style-type: none"> Write your first name Cut it apart Put it back together Repeat 	Practice cutting with scissors	Make up a story together	Make a color pattern	Practice writing your last name	Look in a newspaper for all of the letters in your name and cut them out
Find and count all of the squares in your house	Find and count all of the circles in your house	Find and count all of the rectangles in your house	Find and count all of the triangles in your house	Sort your toys by big and little	Sort your toys by color	Name three words that rhyme with dog
Write a letter to a friend or relative	Practice writing your name with different colored crayons	Practice saying your birth date and write it down	Count how many days until school starts	Practice tying your shoes	Write your name using outside chalk	Name three words that rhyme with book
Think of words that start with the same letter as your name	Draw a circle, square, triangle and rectangle	Write the numbers you see on the calendar	Name three words that rhyme with bat	Practice writing your last name and naming the letters	Find things in your house that start with the first letter of your last name	Read a book and talk about the characters and setting

The Flag and the Pledge of Allegiance!

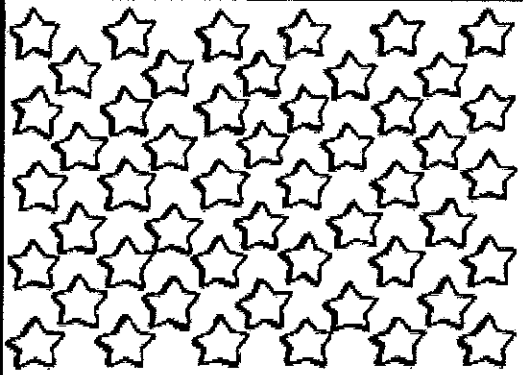
	
	I pledge allegiance
	to the flag of the
	United States of America
and to the Republic for which it stands,	
one Nation, under God, indivisible	
with liberty and justice for all.	

Please practice reciting
The Pledge of Allegiance
with your child.